

2005-7-12 ①

RECORDED IN OFFICIAL RECORDS  
INSTRUMENT # 2005152285 4 PGS  
2005 JUL 12 05:36 PM  
KAREN E. RUSHING  
CLERK OF THE CIRCUIT COURT  
SARASOTA COUNTY, FLORIDA  
KONESS Receipt#654673

✓ This Instrument Prepared By:  
Margaret S. Frook, Esquire  
BOONE, BOONE, BOONE, KODA & FROOK, P.A.  
P.O. Box 1596  
Venice, Florida 34284



4

**FOURTH AMENDMENT TO DECLARATION OF CONDOMINIUM OF  
MIRABELLA, A CONDOMINIUM**

MIRABELLA CONDOMINIUMS, LLC, a Florida limited liability company (hereinafter "Developer"), pursuant to Section 5.2 of the Declaration of Condominium of Mirabella, a Condominium, as recorded in Official Records Instrument #2005008122, public records of Sarasota County, Florida, as amended (the "Declaration"), does hereby amend the Declaration, as follows:

The Surveyor's Certificate indicating the substantial completion of Building #7 of Phase 2 (containing Units 7101, 7102, 7201, 7202, 7301, 7302, 7401, and 7402) is attached hereto and incorporated herein.

All other provisions of the above-described Declaration, as amended, shall remain in full force and effect. This Amendment is made and entered into this 29<sup>th</sup> day of June, 2005.

Witnesses:

Sign Tammy Lindemuth  
Print Tammy Lindemuth  
Sign Kenneth Dec  
Print Kenneth Dec

MIRABELLA CONDOMINIUMS, LLC, a  
Florida limited liability company  
By Michael W. Miller  
Michael W. Miller, as Managing  
Member

**STATE OF FLORIDA  
COUNTY OF SARASOTA**

**I HEREBY CERTIFY** that the foregoing Amendment to Declaration of Condominium was acknowledged before me this 29 day of June, 2005, by Michael W. Miller, as Managing Member of MIRABELLA CONDOMINIUMS, LLC, a Florida limited liability company, on behalf of the company. He is personally known to me or produced power as identification.

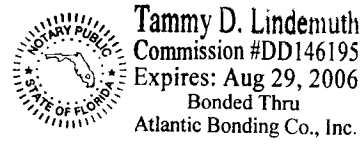

(SEAL)  
My Commission Expires:

NOTARY PUBLIC  
Sign Tammy D Lindemuth  
Print Tammy D Lindemuth

# STRAYER SURVEYING & MAPPING, INC.

## CERTIFICATE OF SURVEYOR

I, the undersigned Registered Surveyor & Mapper, hereby certify as follows:

1. This certificate is made with respect to the following Condominium: "MIRABELLA" A CONDOMINIUM, as per the plat recorded in Condominium Book 37, Pages 25-25C, Public records of Sarasota County, Florida. This Certificate involves Units 7101-7102, 7201-7202, 7301-7302, 7401-7402, within said Condominium, Building 7, Phase 2.
2. The construction of the improvements within said Condominium pertaining to the respective Units is substantially complete.
3. The plat (as amended by the pages attached hereto, if applicable) together with the provisions of the Declaration describing the Condominium property, recorded in official record instrument number 2005008122 of the public records of Sarasota County, Florida, is an accurate representation of the locations and dimensions of Building 7 and Units therein.
4. The identification, location and dimensions of the common elements and of each Unit can be determined from the plat, as hereby amended, and the provisions of said Declaration.
5. All planned improvements, including, but not limited to, landscaping, utility services and access to said Units, and the common element facilities serving the Units, and the Building in which the Units are located, have been substantially completed.
6. Sheet 3 of 4, Page 25-B, of the Recorded Plat of "MIRABELLA" A Condominium, as per the plat recorded in Condominium Book 37, Pages 25-25C, Public records of Sarasota County, Florida, has been modified to indicate unit interior layout adjustments. Sheet 4 of 4, Page 25-C, of said Plat, has been modified to add a typical cross section of Building 7. The cross section shows the upper units of Building 7, and the vertical heights of the vaulted ceilings. The modified pages are attached hereto.

Strayer Surveying & Mapping, Inc.  
Licensed Surveyor Business No. 6639

  
Robert B. Strayer, Jr.  
FL Surveyor Certificate No. 5027

Strayer Surveying & Mapping, Inc.  
763 Shamrock Blvd.  
Venice, FL 34293  
Ph. (941) 497-1290

Date: 6/22/05  
Page 1 of 3

# MIRABELLA

A CONDOMINIUM

LYING IN SECTION 10, TOWNSHIP 39 SOUTH, RANGE 19 EAST  
CITY OF VENICE, SARASOTA COUNTY, FLORIDA

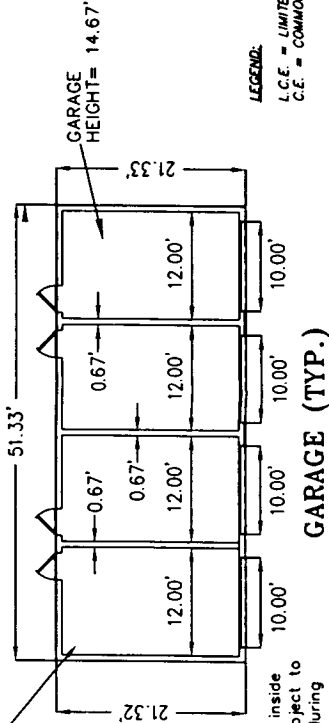
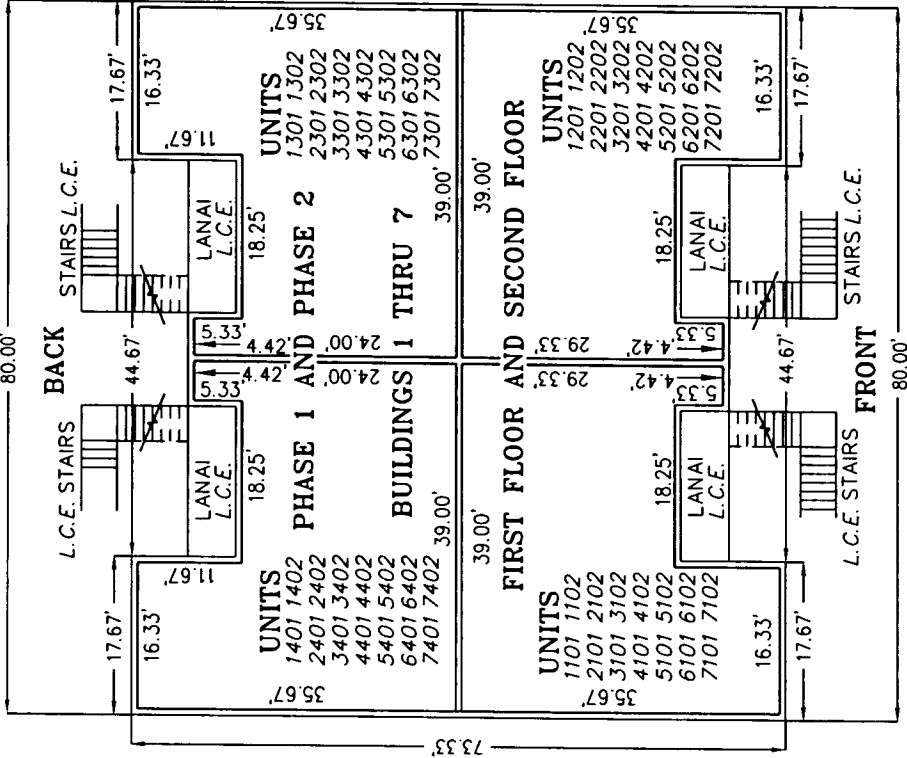
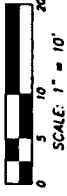

- SURVEYOR'S NOTES:**
- UNIT BOUNDARIES:** EACH UNIT SHALL INCLUDE THAT PART OF THE BUILDING CONTAINING THE UNIT THAT LIES WITHIN THE FOLLOWING BOUNDARIES:
- (A) **UPPER AND LOWER BOUNDARIES:** THE UPPER AND LOWER BOUNDARIES OF THE UNIT SHALL BE THE FOLLOWING BOUNDARIES EXTENDED TO THEIR PLANAR INTERSECTIONS WITH THE PERIMETRICAL BOUNDARIES.
  - (1) **UPPER BOUNDARIES:** THE HORIZONTAL PLANE OF THE UNFINISHED LOWER SURFACE OF THE CEILING
  - (II) **LOWER BOUNDARIES:** THE HORIZONTAL PLANE OF THE UNFINISHED UPPER SURFACE OF THE FLOOR OF THE UNIT
  - (B) **PERIMETRICAL BOUNDARIES:** THE PERIMETRICAL BOUNDARIES OF THE UNIT SHALL BE THE VERTICAL PLANES OF THE UNFINISHED INTERIOR SURFACES OF THE WALLS BOUNDING THE UNIT EXTENDED TO THEIR PLANAR INTERSECTIONS WITH EACH OTHER AND WITH THE UPPER AND LOWER BOUNDARIES.
  - (C) **APERTURES:** WHERE THERE ARE APERTURES IN ANY BOUNDARY, INCLUDING, BUT NOT LIMITED TO, WINDOWS AND DOORS, THE BOUNDARIES OF THE UNIT EXTEND TO THE INTERIOR SURFACE OF ALL WINDOWS (WHICH TERM DOES NOT INCLUDE SLIDING GLASS DOORS BUT DOES INCLUDE GLASS CURTAIN WALLS) AND EXTEND TO THE EXTERIOR SURFACE OF SLIDING GLASS DOORS AND UNFINISHED EXTERIOR SURFACES OF EXTERIOR DOORS. THE FRAMEWORK FOR WINDOWS (AGAIN NOT INCLUDING FRAMEWORK FOR SLIDING GLASS DOORS) SHALL NOT BE INCLUDED IN THE BOUNDARIES OF THE UNIT AND SHALL BE COMMON ELEMENTS.
  - (D) **UTILITY EQUIPMENT AND FIXTURES:** THE UNITS SHALL INCLUDE ALL PLUMBING AND ELECTRICAL LINES, EQUIPMENT AND FIXTURES LOCATED WITHIN THE BOUNDARIES OF THE UNIT, TOGETHER WITH PLUMBING AND ELECTRICAL AND OTHER UTILITY LINES WITHIN THE COMMON ELEMENTS WHICH SERVE THE UNIT ONLY. THE UNIT SHALL NOT INCLUDE ELECTRICAL AND PLUMBING LINES, CONDUITS, EQUIPMENT, FIXTURES, PIPES, WIRES, AIR PASSAGEWAYS, DUCTS, OR OTHER UTILITY LINES RUNNING THROUGH OR ADJACENT TO THE UNIT WHICH ARE UTILIZED FOR OR SERVE ANOTHER UNIT OR THE COMMON ELEMENTS, WHICH ITEMS SHALL BE MADE A PART OF THE COMMON ELEMENTS.
  - (E) **AIR CONDITIONING/HEATING:** ANY AIR CONDITIONING/HEATING EQUIPMENT WHICH SERVES ONLY A SINGLE UNIT SHALL BE CONSIDERED PART OF SAID UNIT AND NOT A COMMON ELEMENT.
  - (F) **APPLIANCES:** THE UNIT OWNER SHALL OWN ANY ELECTRIC DOORBELLS/KNOCKERS, HOT WATER HEATERS, REFRIGERATORS, DISHWASHERS, ELECTRIC GARAGE DOOR OPENERS, GARAGE DOORS, AND OTHER APPLIANCES WHICH ARE LOCATED WITHIN THE BOUNDARIES OF THE UNIT OR THE LIMITED COMMON ELEMENTS.
  - (G) **FIXTURES:** THE UNIT OWNER SHALL OWN ALL INTERIOR FIXTURES WHICH SHALL SERVE THE UNIT EXCLUSIVELY, INCLUDING WITHOUT LIMITATION, ALL PLUMBING FIXTURES, UTILITY AND ELECTRICAL FIXTURES AND CABINETS.
  - (H) **EXCEPTIONS:** IN CASES NOT SPECIFICALLY COVERED ABOVE, AND/OR IN ANY CASE OF CONFLICT OR AMBIGUITY, THE SURVEY OF THE UNITS SET FORTH AS EXHIBIT "A" HERETO SHALL CONTROL IN DETERMINING THE BOUNDARIES OF A UNIT, EXCEPT THAT THE PROVISIONS OF SECTION 3.3(C) ABOVE SHALL CONTROL UNLESS SPECIFICALLY DEPICTED OTHERWISE ON SUCH SURVEY.
  - (I) **LIMITED COMMON ELEMENTS:** ASSIGNED PARKING SPACES, AND LANAI AREAS ARE LIMITED COMMON ELEMENTS.
  - (J) **COMMON ELEMENTS:** THE SIDEWALKS, UNASSIGNED PARKING SPACES, CLUB HOUSE AND POOL AS DEPICTED ON THE SURVEY AND PLOT PLAN ARE COMMON ELEMENTS, WITH THE EXCEPTION OF ASSIGNED PARKING SPACES.

**NOTES:**  
ARCHITECTURAL DRAWINGS WERE PROVIDED BY WATERFORD HOMES DATED 6-27-03.  
REFER TO THE FULL SET OF ARCHITECTURAL DRAWINGS FOR INDIVIDUAL INTERNAL UNIT DIMENSIONS, LAYOUT, AND CEILINGS.

**LEGEND:**  
L.C.E. = LIMITED COMMON ELEMENT  
C.E. = COMMON ELEMENT

**Strayer Surveying & Mapping, Inc.**  
763 Shamrock Boulevard  
Venice, Florida 34293  
(941) 496-9488  
Fax (941) 497-6186  
e-mail address - strayersurveying@comcast.net

335 Tamiami Trail  
Port Charlotte, Florida 33953  
(941) 624-4900  
Fax (941) 624-3471

**NOTE:** All unit dimensions refer to inside dimensions of the unit and are subject to slight variances which may occur during construction.

GARAGE FLOOR TO BE CONSTRUCTED WITH CONCRETE (SEE ARCHITECTURAL PLANS)

# MIRABELLA

A CONDOMINIUM

LYING IN SECTION 10, TOWNSHIP 39 SOUTH, RANGE 19 EAST  
CITY OF VENICE, SARASOTA COUNTY, FLORIDA

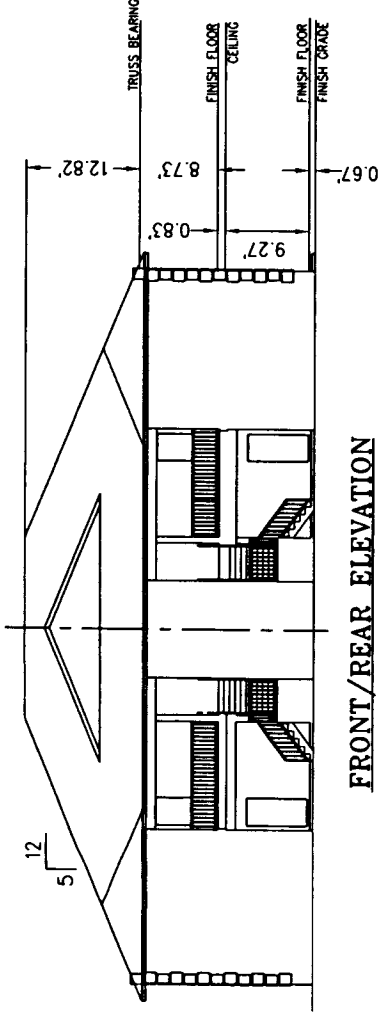
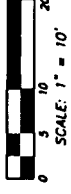

**FRONT/REAR ELEVATION**

NOTE: All unit dimensions refer to inside dimensions of the unit and are subject to slight variances which may occur during construction.

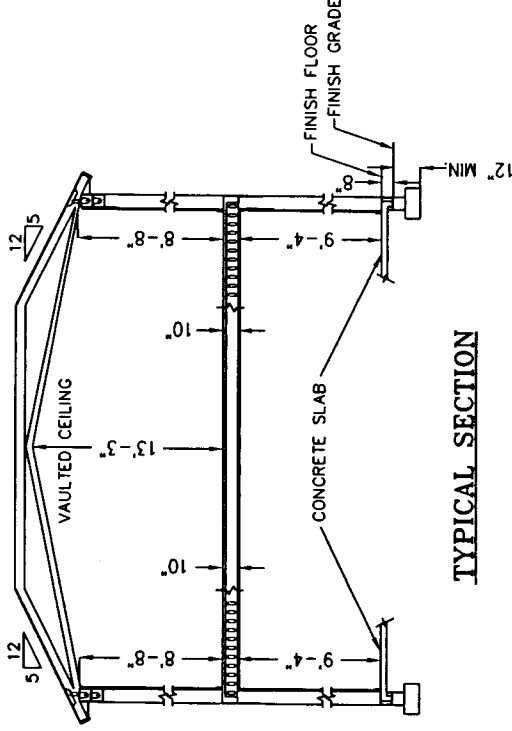

**TYPICAL SECTION**

NOTE:  
ARCHITECTURAL DRAWINGS WERE PROVIDED BY  
WATERFORD HOMES DATED 6-27-03.  
REFER TO THE FULL SET OF ARCHITECTURAL DRAWINGS  
FOR INDIVIDUAL UNIT DIMENSIONS AND LAYOUT.

- SURVEYORS NOTES:**
- UNIT BOUNDARIES:** EACH UNIT SHALL INCLUDE THAT PART OF THE BUILDING CONTAINING THE UNIT THAT LIES WITHIN THE FOLLOWING BOUNDARIES:
- (A) **UPPER AND LOWER BOUNDARIES:** THE UPPER AND LOWER BOUNDARIES OF THE UNIT SHALL BE THE FOLLOWING BOUNDARIES EXTENDED TO THEIR PLANAR INTERSECTIONS WITH THE PERIMETRICAL BOUNDARIES.
  - (I) **UPPER BOUNDARIES:** THE HORIZONTAL PLANE OF THE UNFINISHED LOWER SURFACE OF THE CEILING
  - (II) **LOWER BOUNDARIES:** THE HORIZONTAL PLANE OF THE UNFINISHED UPPER SURFACE OF THE FLOOR OF THE UNIT
  - (B) **PERIMETRICAL BOUNDARIES:** THE PERIMETRICAL BOUNDARIES OF THE UNIT SHALL BE THE VERTICAL PLANES OF THE UNFINISHED INTERIOR SURFACES OF THE WALLS BOUNDING THE UNIT EXTENDED TO THEIR PLANAR INTERSECTIONS WITH EACH OTHER AND WITH THE UPPER AND LOWER BOUNDARIES.
  - (C) **APERTURES:** WHERE THERE ARE APERTURES IN ANY BOUNDARY INCLUDING, BUT NOT LIMITED TO, WINDOWS AND DOORS, THE BOUNDARIES OF THE UNIT EXTEND TO THE INTERIOR SURFACE OF ALL WINDOWS (WHICH TERM DOES NOT INCLUDE SLIDING GLASS DOORS BUT DOES INCLUDE GLASS CURTAIN WALLS) AND EXTEND TO THE EXTERIOR SURFACE OF SLIDING GLASS DOORS AND UNFINISHED EXTERIOR SURFACES OF EXTERIOR DOORS. THE FRAMEWORK FOR WINDOWS (AGAIN NOT INCLUDING FRAMEWORK FOR SLIDING GLASS DOORS) SHALL NOT BE INCLUDED IN THE BOUNDARIES OF THE UNIT AND SHALL BE COMMON ELEMENTS.
  - (D) **UTILITY EQUIPMENT AND CONDUITS:** THE UNITS SHALL INCLUDE ALL PLUMBING AND ELECTRICAL LINES, EQUIPMENT AND FIXTURES LOCATED WITHIN THE BOUNDARIES OF THE UNIT TOGETHER WITH PLUMBING AND ELECTRICAL AND OTHER UTILITY LINES WITHIN THE COMMON ELEMENTS WHICH SERVE THE UNIT ONLY. THE UNIT SHALL NOT INCLUDE ELECTRICAL AND PLUMBING LINES, CONDUITS, EQUIPMENT, FIXTURES, PIPES, WIRES, AIR PASSAGEWAYS, DUCTS, OR OTHER UTILITY LINES RUNNING THROUGH OR ADJACENT TO THE UNIT WHICH ARE UTILIZED FOR OR SERVE ANOTHER UNIT OR THE COMMON ELEMENTS, WHICH ITEMS SHALL BE MADE A PART OF THE COMMON ELEMENTS.
  - (E) **AIR CONDITIONING/HEATING:** ANY AIR CONDITIONING/HEATING EQUIPMENT WHICH SERVES ONLY A SINGLE UNIT SHALL BE CONSIDERED PART OF SAID UNIT AND NOT A COMMON ELEMENT.
  - (F) **APPLIANCES:** THE UNIT OWNER SHALL OWN ANY ELECTRIC DOORBELL/SWITCHES, HOT WATER HEATERS, REFRIGERATORS, DISHWASHERS, ELECTRIC GARAGE DOOR OPENERS, GARAGE DOORS, AND OTHER APPLIANCES WHICH ARE LOCATED WITHIN THE BOUNDARIES OF THE UNIT OR THE LIMITED COMMON ELEMENTS.
  - (G) **FIXTURES:** THE UNIT OWNER SHALL OWN ALL INTERIOR FIXTURES WHICH SHALL SERVE THE UNIT EXCLUSIVELY INCLUDING WITHOUT LIMITATION, ALL PLUMBING FIXTURES, UTILITY AND ELECTRICAL FIXTURES AND CABINETS.
  - (H) **EXCEPTIONS:** IN CASES NOT SPECIFICALLY COVERED ABOVE, AND/OR IN ANY CASE OF CONFLICT OR AMBIGUITY, THE SURVEY OF THE UNITS SET FORTH AS EXHIBIT "A" HERETO SHALL CONTROL IN DETERMINING THE BOUNDARIES OF A UNIT, EXCEPT THAT THE PROVISIONS OF SECTION 3.3(C) ABOVE SHALL CONTROL UNLESS SPECIFICALLY DEPICTED OTHERWISE ON SUCH SURVEY.
  - (I) **LIMITED COMMON ELEMENTS:** ASSIGNED PARKING SPACES, AND LANAI AREAS ARE LIMITED COMMON ELEMENTS.
  - (J) **COMMON ELEMENTS:** THE SIDEWALKS, UNASSIGNED PARKING SPACES, CLUB HOUSE AND POOL AS DEPICTED ON THE SURVEY AND PLOT PLAN ARE COMMON ELEMENTS, WITH THE EXCEPTION OF ASSIGNED PARKING SPACES.

*Stayer Surveying & Mapping, Inc.*  
783 Shamrock Boulevard  
Venice, Florida 34293  
(941) 496-9488  
Fax (941) 497-6186  
e-mail address - stayersurveyingmap@comcast.net

335 Tomiami Trail  
Port Charlotte, Florida 33953  
(941) 624-4900  
Fax (941) 624-3471